

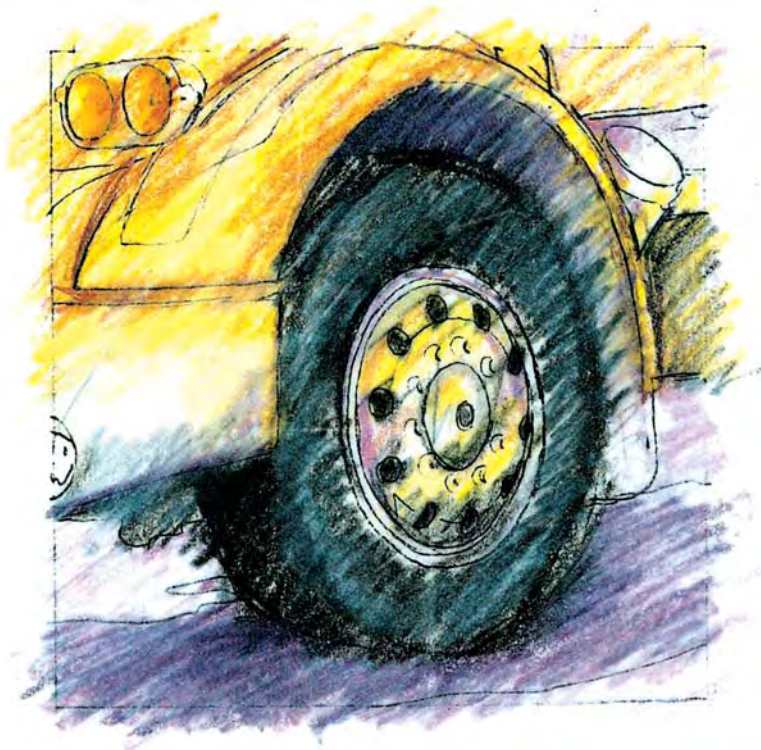

# Trucks and Recreational Vehicles

---



**101**



## Truck Class Licenses

---

South Carolina issues licenses as proof that you've been examined and are qualified to operate a particular type of vehicle. You must be at least 18 years of age to apply for one of the following licenses:

### Commercial

**Class A:** Any combination of vehicles with a GCWR of 26,001 or more pounds provided the GVWR of the vehicle(s) is being towed is in excess of 10,000 pounds.

**Class B:** Any single vehicle with a GVWR of 26,001 or more pounds, or any such vehicle towing a vehicle not in excess of 10,000 pounds GVWR.

**Class C:** Any single vehicle, or combination of vehicles, that does not meet the definitions of Class A or B, but either is designed to transport 16 or more passengers, including the driver, or is placarded for hazardous materials.

**For information about a commercial driver's license, please see the [South Carolina Commercial Driver License Manual](#).**

### Non-Commercial

**Class E:** Allows the same driving privileges as a Class D (regular passenger vehicle) and Class G (moped) licenses, plus single unit vehicles weighing over 26,000 pounds gross weight that do not meet the definition of Class A, B or C.

**Class F:** Allows the operation of all Class D, E and G vehicles, plus all other combinations of vehicles with a gross vehicle weight (GVW) in excess of 26,000 pounds that do not meet the definition of Class A, B and C.

The information in this section applies for Class E and F licenses, which do not allow a driver to operate a commercial motor vehicle.

If you plan to operate a motor home that weighs more than 26,000 lbs. GVW, you must obtain a Class E license. If you operate a motor home that weighs more than 26,000 lbs. and tow a trailer or other vehicle, you must have a Class F license. You may take the Class E and F knowledge tests at any SCDMV office. Due to the space required for a Class E or F skills test, these tests must be taken at one of the 36 SCDMV offices that offer commercial driver license testing.

During the basic skills portion of the Class F test, motor home operators will be allowed to disconnect the towed vehicle. However, the towed vehicle must be reconnected for the road test portion of the skills test.



## The Licensing Procedure

---

The basic requirements for obtaining a non-commercial Class E or F driver's license are as follows:

1. You must pass an eye examination.
2. You must be physically and mentally able to drive.
3. You must understand the meaning of the different traffic signs, signals and pavement markings.
4. You must have your vehicle in good condition.
5. You must know and understand how to safely maneuver your vehicle on the streets and highways.
6. You must show you can respect the rights of other drivers, pedestrians, motorcyclists and bicyclists who share the road with you.
7. You must surrender your beginner's permit or current driver's license upon successful completion of the driving test.
8. You must be at least 18 years of age.
9. You will need to study all of the material in this guide (except the motorcycle and moped sections) in order to pass the test.



## Driving Requirements

---

Some of the requirements of the driving test on which you will be graded are:

### Good Posture

You will be expected to maintain good posture during your examination. Your ability to operate a vehicle properly and safely will depend in part on your seat adjustment. Your seat must be positioned so that you can adjust the mirrors for good visibility, reach the various foot pedals and have a controlled grip on the steering wheel.

### Mirrors

Mirror use is vital. While driving a large vehicle, you should check your mirrors constantly to be aware of the traffic conditions around you at all times.

### Starting From Parked Position

You must select the proper gear, operate the clutch smoothly, signal your intentions, and check your mirrors before leaving the curb area.

### Clutch Operations

You must show familiarity and smoothness in operations.



### **Gears**

You must select the proper gear and gear pattern and shift without clashing, forcing or snapping.

### **Braking**

You must be able to stop your vehicle smoothly without a jerk or rebound at the end of the stop.

### **Following**

You must keep a safe distance behind the vehicle ahead of you in case it should make a sudden stop.

### **Passing**

You must be able to pass legally and safely without interfering with other traffic.

### **Lane Position**

You must keep your vehicle in the proper lane without veering across the center line or off the right side of pavement.

### **Intersection**

You must maintain the proper safe speed, looking in both directions, and be prepared to stop if traffic on the cross street fails to stop.

### **Turning**

You must give proper signals and be in a proper lane position and at the proper speed when turning.

### **Stop Line**

Stopping at a stop line will test your ability to judge the location of the front bumper so that you will not run over crosswalks and other areas where stops are required.

### **The Serpentine**

You must be able to maneuver in and out of tight places.

### **Backing**

You must be able to back your vehicle slowly for a distance of 100 feet as straight and smoothly as possible and to demonstrate use of the mirrors while doing so.

### **Alley Dock Backing**

In this simulated maneuver of backing to loading platform, you must back your vehicle in a continuous movement into an area 90 degrees from the area you backed from.



### Using Horn

Use the horn only when necessary to warn pedestrians, motorcyclists, bicyclists or others who share the road with you. You should use your horn also when backing.

### Stopping And Starting On Grade

When a vehicle is parked, the parking brake must be set and the transmission placed in reverse, or the lowest forward gear. If there is a curb, the front wheels should be turned toward the curb on a downgrade or level surface and turned away from the curb when parking on an upgrade. If the steepness of the grade or other factors increase the danger of a runaway vehicle, you should use chock blocks. Never park on a steep grade unless absolutely necessary.

### Standard Road Driving

Normal on-road driving practice.

## Proper Driving Techniques

---

### Pre-trip Inspection

Before the driving demonstration begins, the examiner, with your assistance, will inspect the vehicle and its equipment. You should check your vehicle before appearing at the examining station to make sure all equipment is operating properly. Drivers should inspect their vehicles before each trip. The driver is responsible for making sure that the truck is in a safe condition. Follow these procedures:

- **Step One: Initial Vehicle Check**

Enter cab using the three-point method for safety--having one foot and both hands on the truck at all times, or two feet and one hand.

1. Make sure your vehicle is secured properly.
2. Depress the clutch and place the gearshift in neutral.
3. Start the engine, and check:
  - A. Oil pressure gauge for proper pressure.
  - B. Ammeter.
  - C. Horn.
  - D. Windshield wipers.
  - E. Engine for unusual noises.
  - F. Air pressure.

With the engine running, build air pressure to 100-125 psi. Shut engine off. Release tractor protection valve and push parking brake in. Fully depress brake pedal; hold for one minute. Pressure loss should not exceed 3 psi for single vehicle, 4 psi for combination unit. Begin fanning



brakes; low air warning device (buzzer-light-flag) should activate before air pressure drops below 60 psi. Continue fanning brakes at approximately 40 psi. The tractor protection valve and parking brakes should close (pop out). If vehicle fails air brake check, the test will be discontinued. In the event the vehicle is equipped with vacuum or hydraulic brakes, depress the brake pedal and hold it down. If brake pressure will not hold, the test will be discontinued.

● **Step Two: Outside the Vehicle**

Set the parking brakes, turn on all lights, leave the cab and begin your equipment inspection. Start at the left front wheel and proceed around in a counterclockwise direction.

1. Lights and reflectors should be clear.
2. Check tires for wear and cuts and to ensure proper inflation.
3. Check the wheels for missing lug nuts.
4. Make sure the trailer landing gear is raised and the handle is secure.
5. Ensure that the fifth-wheel jaws and release lever are in the locked position.
6. Check brake lines for leaks and wear, and electric lines for excessive wear.
7. On combination units, check lights and brake connections between power unit and trailer by hand to make sure of tightness.
8. Check emergency warning equipment (you should have three devices).
9. Check general overall vehicle appearance (Are rear doors closed? Are there any loose fenders, torn metal, etc., exposed enough to be hazardous?).
10. Check the headlights (both upper and lower beams), directional signals, stoplights, emergency flashers. For these operations, you will re-enter the cab. The examiner will check these from outside.

● **Step Three: Inside the Vehicle**

1. Adjust the seat and then the mirrors.
2. With trailer brakes on, put the gear shift lever in the lowest forward gear, release the parking brake on the tractor and by gently releasing the clutch, check the coupling between the tractor and trailer. This procedure will also check the trailer brake. Check the tractor protection valve.
3. After checking the coupling between the tractor and the trailer, release the trailer brakes, then release the clutch pedal gently. With the vehicle in motion, check the foot brake.





### Starting The Engine

1. Engage the parking brake, place the transmission in neutral, adjust the choke, and depress the clutch pedal.
2. Turn on the ignition, and operate the starter.
3. Control the engine with the foot throttle until it is running smoothly.
4. When the engine is running smoothly, set the hand throttle at a fast idle and allow the engine to warm up before attempting to move the vehicle.
5. On air brake vehicles, the air pressure gauge should register sufficient pressure before the vehicle is moved. The audible warning buzzer must have stopped and/or the warning light must be off.

### Putting The Vehicle Into Motion

1. On a combination vehicle, test the hookup in one of the following ways before attempting to move the vehicle:
  - A. Place the transmission in reverse, partially engage the clutch and speed up the engine to make the power unit go backward smoothly until the fifth-wheel jaws engage the kingpin.
  - B. Apply the trailer brakes and pull forward to see if the fifth wheel is locked. Then check visually to see if it is secure.
2. Disengage the clutch and place the transmission in the lowest forward gear. If the vehicle is equipped with a trailer hand control, pull it down to set the trailer brakes to keep the unit from rolling. If there is no hand control, leave the trailer parking brake set. When starting, gradually release the clutch while releasing the hand control valve or the parking brake as the clutch engages. At the same time, press the accelerator gradually to prevent stalling and to move the load. Do not ride the clutch when it is finally engaged and the vehicle is in motion.
3. The foot brake must be checked immediately after the vehicle is moving, within at least 50 feet during the road test.

### Shifting Up Through The Gears

In each gear, sufficient speed must be built up to avoid lugging the engine in that gear and speed must be sufficient so that engine will not be lugged when the next higher gear is reached.

Double-clutching may be used on most manually shifted truck transmissions except synchro-mesh transmissions. Shifting is faster and smoother when this procedure of depressing the clutch twice with each change of gears is used.



### Shifting Down

Be alert to changing conditions that may require a reduction of speed and shifting down a gear. Do not wait until the engine starts lugging before shifting down. For dangerous down-grades, the gears should be downshifted to make use of engine-braking.

A good driver will downshift before passing the crest of a hill since it is dangerous to downshift past this point. Missing a gear can be dangerous.

If your brakes fail on a level road, you should shift to a lower gear and use engine compression to assist you in stopping the vehicle.

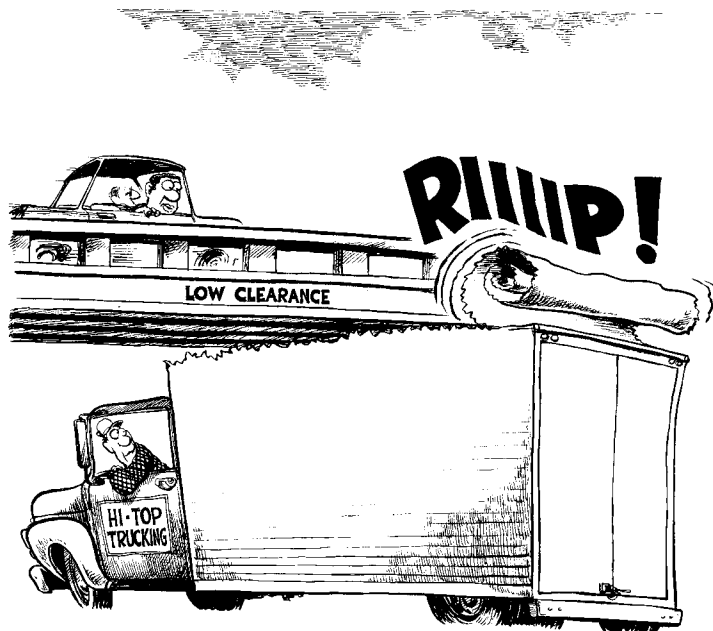

Be aware of your truck's measurements to avoid surprises.

108

### Passing

1. Passing should be attempted only when you have clear and adequate space ahead to complete the pass without racing and without risk to yourself or the vehicle being passed.
2. A signal must be given 100 feet before pulling out to pass. Signal before returning to the right-hand lane when changing lanes.
3. Return to your lane when you can see both headlights of the vehicle being passed in your side-view mirror.
4. On multiple-lane highways, don't pass if you would block faster traffic overtaking from the rear.



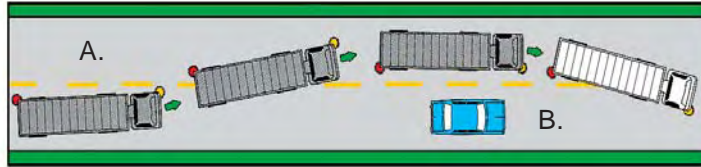

- A. Give proper signal 100 ft. or more before pulling out to pass.  
B. Give proper signal before returning to right hand lane.

### Being Passed

1. When being passed by another vehicle, keep well to the right side, maintain your speed and, if necessary, reduce speed to facilitate safe passing. Never speed up to prevent another driver from passing.
2. Do not signal the driver of an overtaking vehicle that is safe to pass. This is a dangerous practice and is prohibited by the U.S. Department of Transportation. To give such a signal transfers part of the responsibility for safe passing from the overtaking driver to yourself. If an accident occurs after you have given a signal, you could be held liable for any damages.
3. Be alert for the driver who tries to pass in a unsafe place. Don't try to block the passer and be ready to do anything that may be necessary to avoid being involved in an accident.
4. At night, dim your lights after being passed to avoid creating a glare in the other driver's mirror.

### Meeting Other Vehicles

1. Always keep to the far right when meeting any oncoming vehicle. At night, dim your headlights 500 feet from any oncoming vehicle regardless of any action its driver may take.
2. If you see a vehicle approaching on your side of the road, slow down and pull as far to the right as safely as possible and stop. Never pull to the left in an attempt to avoid an oncoming vehicle in your lane.
3. Always sound your horn to warn the driver ahead when you are passing. Headlight signals alone are not a legal warning and must not be used as such.
4. When it is safe, return to the right-hand lane.
5. Never attempt to pass a vehicle when approaching the top of a hill, curve, intersection, side road, bridge, railroad crossing or any place where you do not have a clear view of the road ahead. Make sure you can see the traffic approaching from the side.
6. Standing buses must be passed in accordance with local traffic regulations.
7. Be alert for school buses and ready to make a safe stop if necessary. You must stop for a stopped school bus with flashing lights that is



loading or unloading passengers. This is required by law whether you are meeting the bus or traveling behind it under the following conditions:

- a. On any two-lane highway.
  - b. On any four-lane or multi-lane highway only when traveling behind a school bus.
  - c. When passing a school bus that has red or amber signals flashing.
8. Do not attempt to pass unless there is sufficient difference between your speed and the speed of the slower vehicle so that you can pass without delay.
  9. Do not attempt to pass more than one vehicle at a time. If you try to pass a line of traffic, you may find yourself in a position where you cannot return to the right lane should the need arise.
  10. On multiple-lane highways, take care not to pass when you would block faster traffic overtaking from the rear. On highways with three or more lanes of traffic in the same direction, use only the two right-hand lanes unless passing or when making a legally permitted left turn.



500 FT



Drivers are required to dim headlights 500 ft. from any approaching vehicle, 200 feet from any vehicle you are approaching from the rear.

**110**

### Use of Mirrors

1. A professional driver watches his mirrors nearly as much as he watches the road ahead. Vision is restricted when using mirrors. As a precaution, you should always check for traffic with and without mirrors.
2. Proper adjustment of mirrors is essential in safe driving. To adjust mirrors accurately on a combination unit, the vehicle must be in a straight line. The driver must be in a normal position behind the steering wheel while making adjustments.

### Use of Brakes

1. Allow sufficient distance to avoid the need for sudden stops.
2. Apply brakes with steady pressure at the beginning of a stop and then gradually release as the vehicle slows down.





3. Do not fan brakes except on slippery pavement. Fanning brakes on a long downgrade may reduce brake air pressure below the minimum pressure needed for proper brake operation.
4. Avoid excessive use of brakes on long downgrades. Use engine compression as the principal means of controlling speed on long downgrades and in the mountains.

### **Yielding Right Of Way**

The driver of a vehicle must never “demand” the right-of-way. When approaching an intersection all drivers must exercise due care. The law does not give anyone right-of-way over another; it states only who should yield.

### **Following Other Vehicles**

Drivers should make a habit of never driving too closely behind other vehicles. Allow enough space between you and the vehicle ahead that you can stop easily and safely in an emergency. Always keep in mind adverse conditions such as weather and roads; traffic conditions may require more cautious driving.

Leave enough space between you and the vehicle ahead to allow faster traffic to pass you and return to the right lane. Whenever conditions permit, a truck should not follow another truck or any motor vehicle pulling another motor vehicle closer than 300 feet. At night, if the following distance is within 200 feet, the law requires that you dim your headlights.

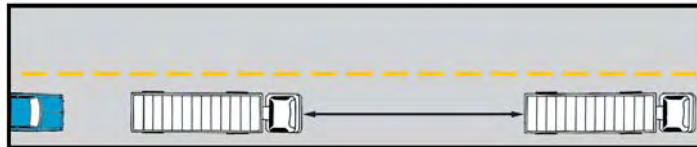

## **Routine Driving Tasks**

Many of the routine driving tasks that you face in driving a truck or recreational vehicle will be similar to driving a car. For the sake of all road users, it is important to be a defensive driver when driving any vehicle.

### **Curves**

Maneuvering around curves and turns in trucks and recreational vehicles requires more skill and care than in cars. Curves and turns must always be executed at a reduced speed consistent with the





available sight distance, the sharpness of the curve or turn and other prevailing road and traffic conditions.

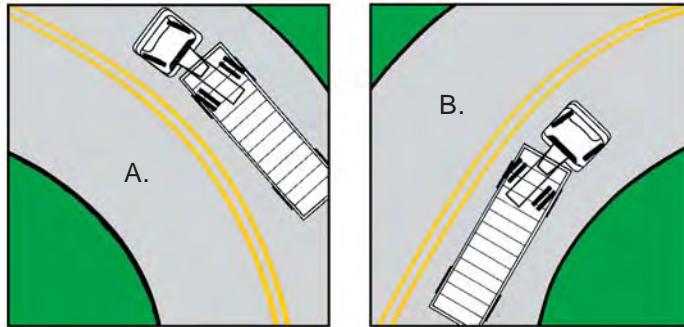

Illustration A shows proper execution for taking a left curve and B, a right curve.

On sharp or right curves, you must lead the turning arc of the front wheels in keeping with the sharpness of the curve and the amount of off-track of your vehicle. On a curve to the right you must keep your front wheels close to the center line to prevent dropping the rear wheels off the pavement or breaking the pavement shoulders. On a curve to the left you must keep your front wheels close to the right edge of the pavement to prevent the rear wheel from crossing into the other traffic lane.

When entering a curve, you must make sure that the speed of your vehicle is slow enough for you to retain control in the curve. If you apply your brakes in a curve your vehicle may skid or jackknife. You may gradually accelerate on a curve only after you have passed the midpoint of the curve. You must enter a curve at a speed that doesn't require braking. Failure to do so greatly increases the chances of "rolling-out", skidding or jackknifing.

## 112 Different Turning Characteristics

The difference between the turning characteristics of a single-unit vehicle, a tractor semitrailer or combination unit are shown in Illustrations A and B.

In Illustration A, note that the rear wheels of the truck follow a shorter path than the front wheels.

In Illustration B, note that the rear wheels of the tractor follow a shorter path than the front wheels of the tractor in turning the corner shown in Illustration A.

The rear wheels of the semitrailer or combination unit follow a still shorter path cutting this corner. Drivers must allow for off-tracking of the rear wheels. The longer the vehicle or combination, the greater the off-track.





## Turns

1. Know where you want to turn ahead of time. Never make a last-minute decision. Check both mirrors for other vehicles and pedestrians to determine if it is safe.
2. It is important to signal your intentions 100 feet before turning. Be sure your signal light is off after completing the turn. Failure to do so tends to create confusion for other drivers.
3. There will be times when faster moving traffic will require you to move into the proper lane much sooner than you ordinarily would in order for you to make a safe turn.
4. Be sure to follow the pavement markings when possible and finish your turn in the proper lane.
5. A major concern while turning will be your “off-track.” On any turn the rear wheels will follow a shorter path than the front wheels. The illustrations will give a clear understanding of your off-tracking position.
6. When executing a right turn, be sure your rear wheels do not run up on and over the curb.

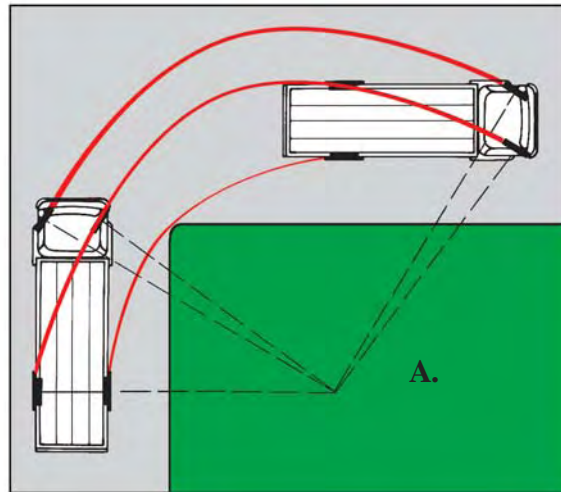

In illustration A, notice the rear wheels of the single-unit vehicle follow a shorter path than the front wheels

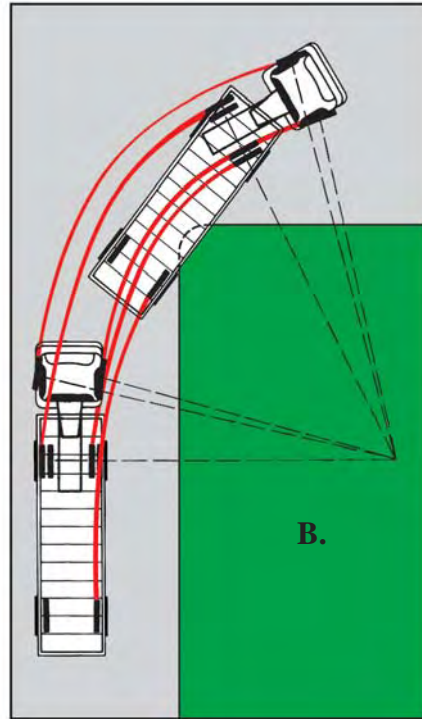

In illustration B, notice the rear wheels of the trailer follow shorter paths than the front wheels of the tractor.

### Right Turns

1. Single-unit vehicles or buses must signal 100 feet before the turn and enter the turn as near to the right curb as possible. Operators of large vehicles must bear in mind that the off-track of the rear wheels will follow a shorter path than the front wheels. You must allow for this on all turns so that your vehicle does not strike another vehicle or a stationary object. Be careful about swinging wide to make a right turn. There is danger that some other driver will try to pass on the right. If you must make a wide turn, the swing should be made wide into the street you are entering.
2. Combination vehicles follow the same procedure in turning as single-unit vehicles, except that the off-track will take a shorter path while turning and the swing-out must be greater. A hazard of the swing-out is the possibility of a vehicle passing on the right. There will be times when you'll have to stop and allow other vehicles to clear the lanes that you are about to enter.

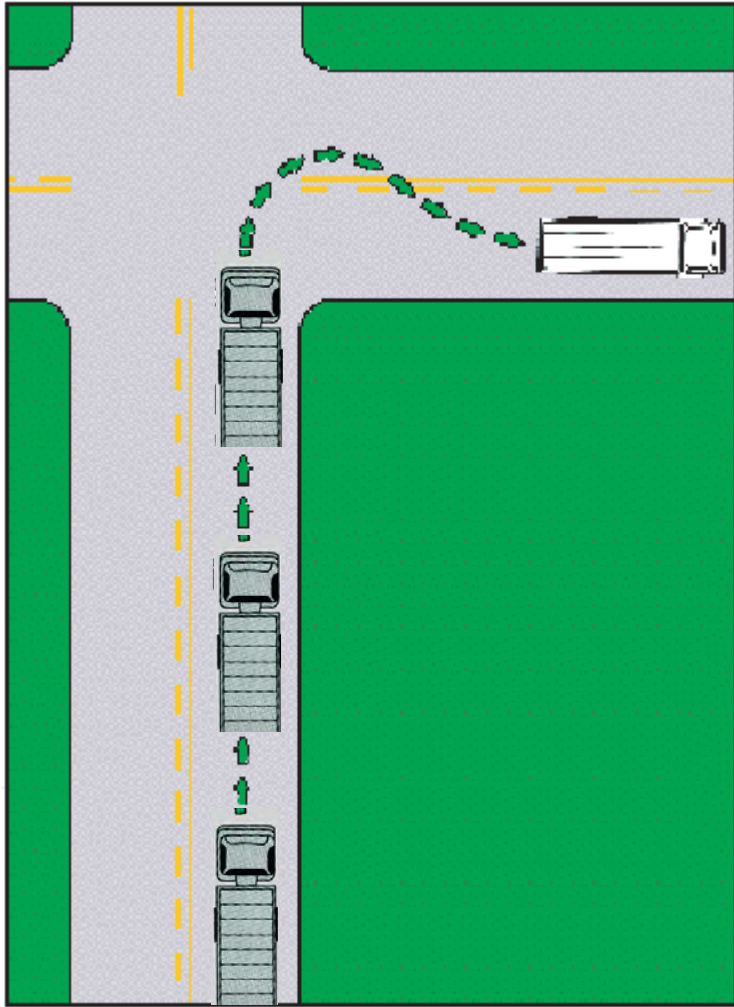

This illustration shows the correct procedure for making a right turn with a single-unit vehicle.

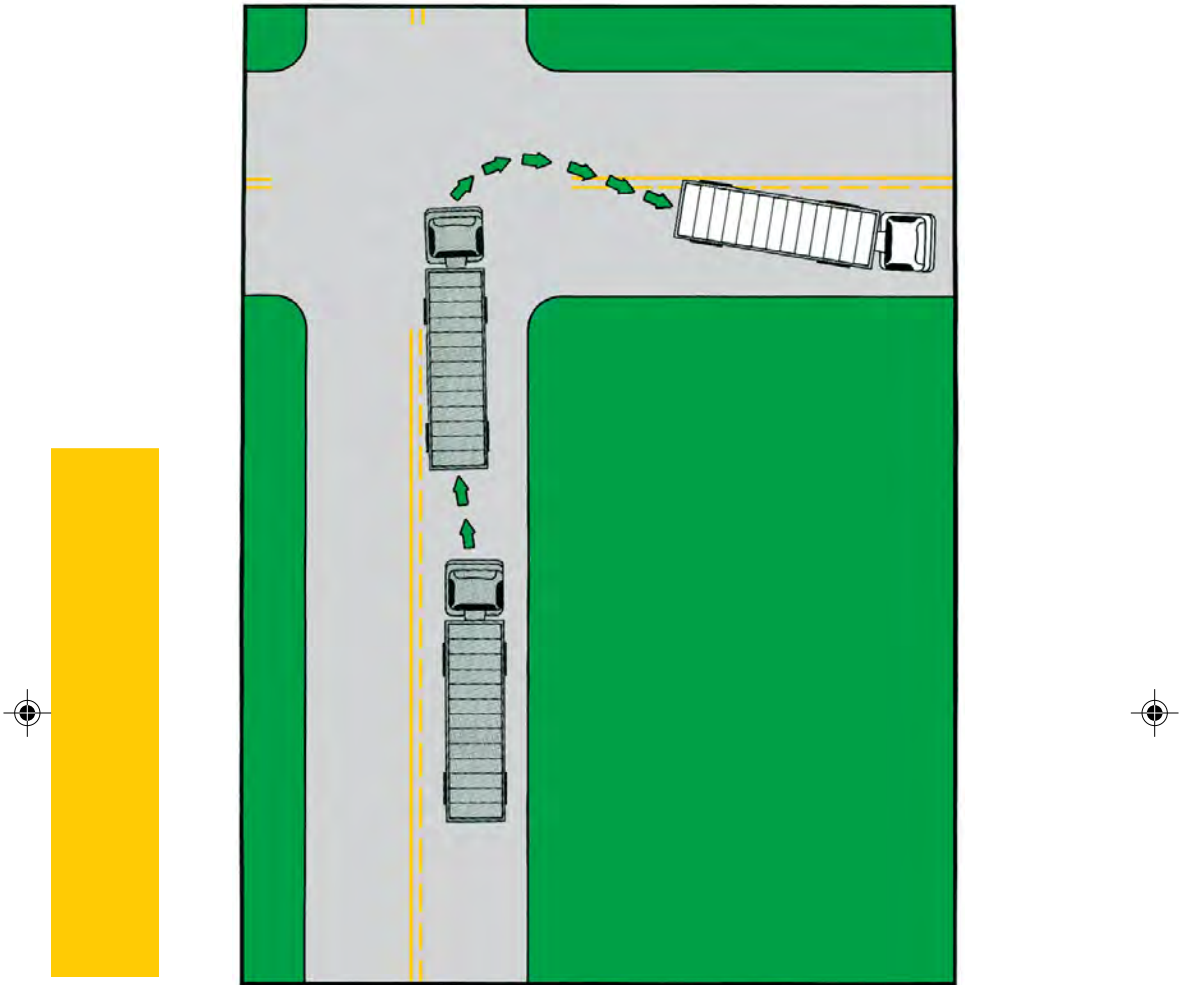

**116** This illustration shows how to make a right turn with a tractor semi-trailer. If the turn is sharp or difficult, swing out into the street you're about to enter. Watch the off-track to avoid running over the curb.

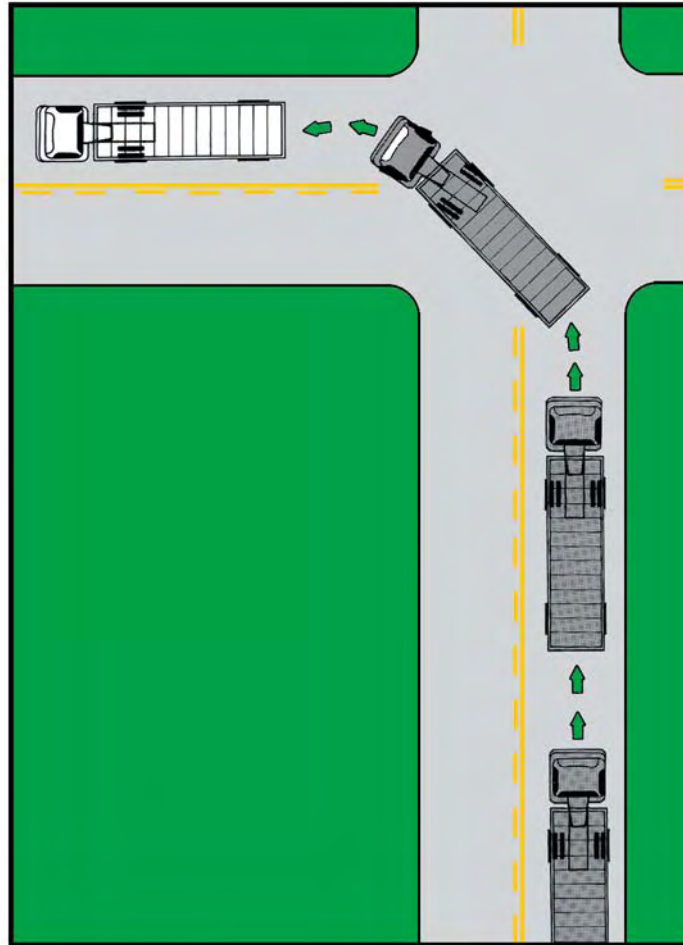

This illustration is the correct procedure for making a left turn with a tractor semi-trailer. The procedure is the same with a single-unit vehicle.

**117**

### **Left Turns**

Slow down when making a left turn. You must get into the lane nearest the center line. Make sure no one is attempting to pass you. Look for traffic approaching toward you, and to the left and right. Your vehicle should be just to the right of the center line as you make your left turn. Watch your off-track while you are turning.





## Backing

A major difficulty for many truck drivers is backing correctly. You must back without interfering with other traffic.

It's a good idea to park safely and walk back to inspect your proposed backing route. Use your outside mirrors and, if possible, have someone stand to the right rear side of the truck while backing to give you directions and assure that you're backing safely. Remember that you are responsible for safe backing, even with a helper.

1. Steering (backing): On a single-unit, you must steer the single-unit vehicle in the direction in which you wish to move the back end of the vehicle.
2. Steering (backing): A combination vehicle will steer opposite to the intended direction to turn the rear of the trailer. The rear axle of the tractor acts as the front axle of the semitrailer and, in effect, steers the semitrailer. The tractor must follow an "S-shaped" course.

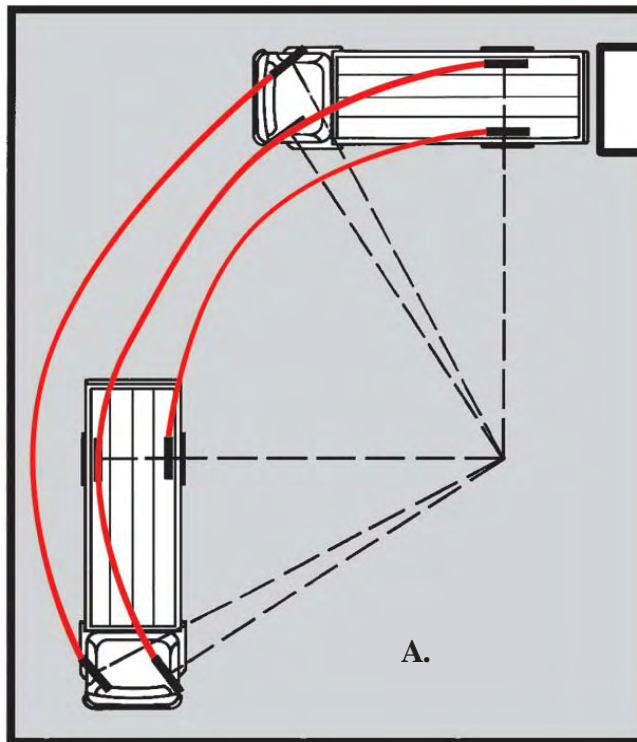

A. Steering (backing) with a single-unit vehicle

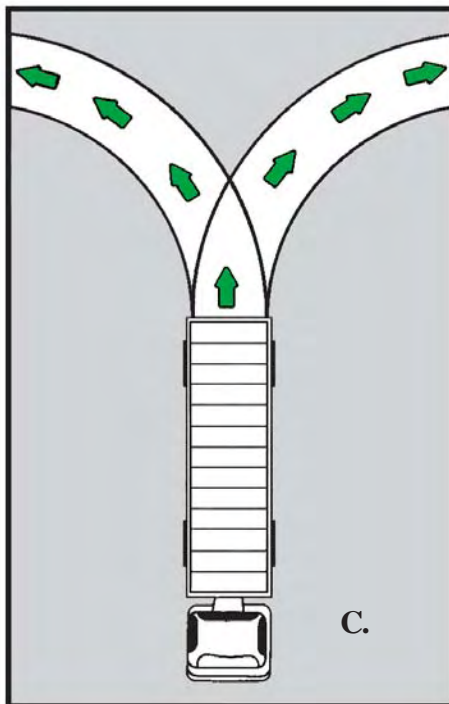
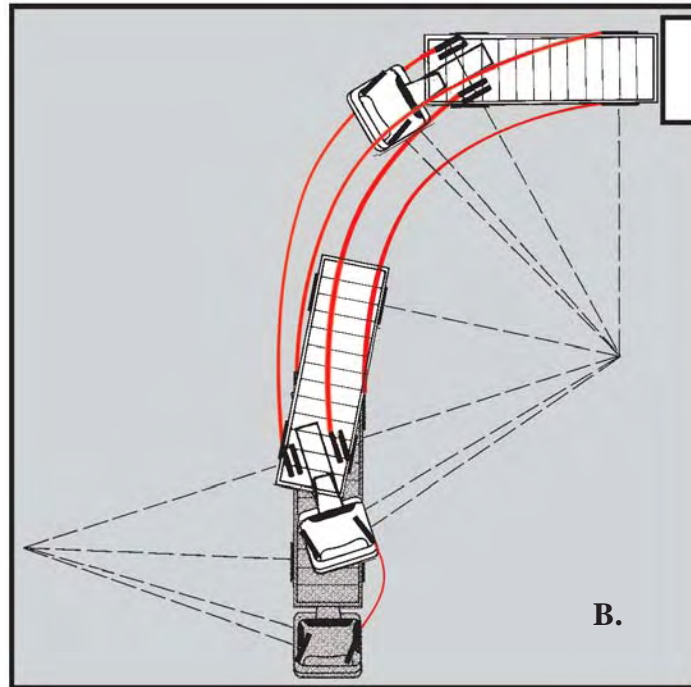

B. Steering (backing) with a tractor semi-trailer

C. Blind side - View side  
When driving a semi-trailer, or single unit trucks, you can back safely on your own. But if you're backing to the blind side, have someone outside to guide you. When backing, have someone to guide you when possible.





## **Hooking-Up/Unhooking Requirements**

---

The procedure for hooking-up and unhooking tractor semitrailer combinations follows:

### **Coupling:**

1. Be sure the jaws of the fifth wheel (coupling device) are fully opened and the fifth-wheel is tilted back so that the hookup can be made without damage. Back slowly and as straight as possible.
2. Line up the kingpin with the fifth-wheel slot. Be certain trailer heights are correct. Back straight and slow.
3. Stop the tractor just as the fifth-wheel makes contact with the trailer.
4. Secure the tractor and check to see if the trailer is secured against movement.
5. Connect the brake lines and electrical connections.
6. Check the trailer brakes with the hand valve and reopen the valve for backing.
7. Back under the trailer without rolling forward.
8. Check the coupling by pulling the tractor forward.
9. Secure the tractor and release the hand valve.
10. Check the coupling from underneath the trailer.
11. Raise the trailer supports and secure the handle in the low-range position.

### **Uncoupling:**

1. Secure the tractor and block the semitrailer, if necessary.
2. Place the tractor protection valve in the emergency position.
3. Lower the trailer supports and secure the handle.
4. Disconnect the emergency air line first.
5. Disconnect the electrical connector and the service air lines.
6. Pull the fifth-wheel hook and lock handle.
7. Pull ahead gradually to allow the trailer landing gear to take up the load gradually.
8. Secure the tractor and check the trailer supports.

Trailers left parked should have the wheels chocked to prevent a roll-away. Air pressure in the trailer air tank will bleed down in proportion to the amount of leakage in the trailer system. If the trailer tank is drained, the trailer brakes will release.

If the trailer is equipped with “spring brakes,” the brakes will remain in the applied position when the air pressure in the system is released.

Always take time to insure that your vehicle is properly coupled. By following the proper procedures and making frequent safety checks, you can greatly lessen the chances of a breakaway.



## **Specific Maneuvers Required During the Test**

The examiner will ask you to perform certain driving maneuvers, including:

### **The Stop Line**

To test your ability to judge the position of the front bumper with respect to a fixed line. This maneuver simulates the conditions encountered in stopping at a marked crosswalk, or a situation in which the driver must pull forward as far as possible in close quarters without touching a stationary object or vehicle.

### **Straight Line Backing**

To test your ability to keep the truck under control while moving backward with the use of mirrors. When backing a combination unit, keep the left rear corner of the trailer in sight at all times. The vehicle must be backed slowly, smoothly and as straight as possible.

### **The Serpentine**

To test your ability to maneuver your vehicle in and out of tight places. This maneuver simulates conditions that might be encountered when disabled or wrecked vehicles partially block the highway, or in negotiating detours in heavy traffic or other situations.

### **Alley Docking**

To test your ability to back your vehicle into a narrow space and stop with the rear of the vehicle within a specified distance of the back limits of the space. This would be similar to backing up to a dock or shipping platform between two other vehicles from a street or yard area with limited space.

### **Backing and Alley Docking: Special Situations, Extra Precautions**

If you are operating a bus, a vehicle with extra width or length or a vehicle carrying a heavy load, you have special responsibilities and must take extra precautions.

1. Buses may create hazards when dropping off or loading passengers, as well as when moving in and out of traffic. Therefore, as a bus driver, responsible for other people, you must be constantly alert.
2. Because of their width, single-unit vehicles have a blind spot of 50 feet or more directly behind them. Be careful when shifting lanes or turning to avoid hitting other vehicles.



Off-street maneuvers

Total length 250 feet  
Width 50 feet  
Alley width 12 feet  
Alley length 25 feet



122

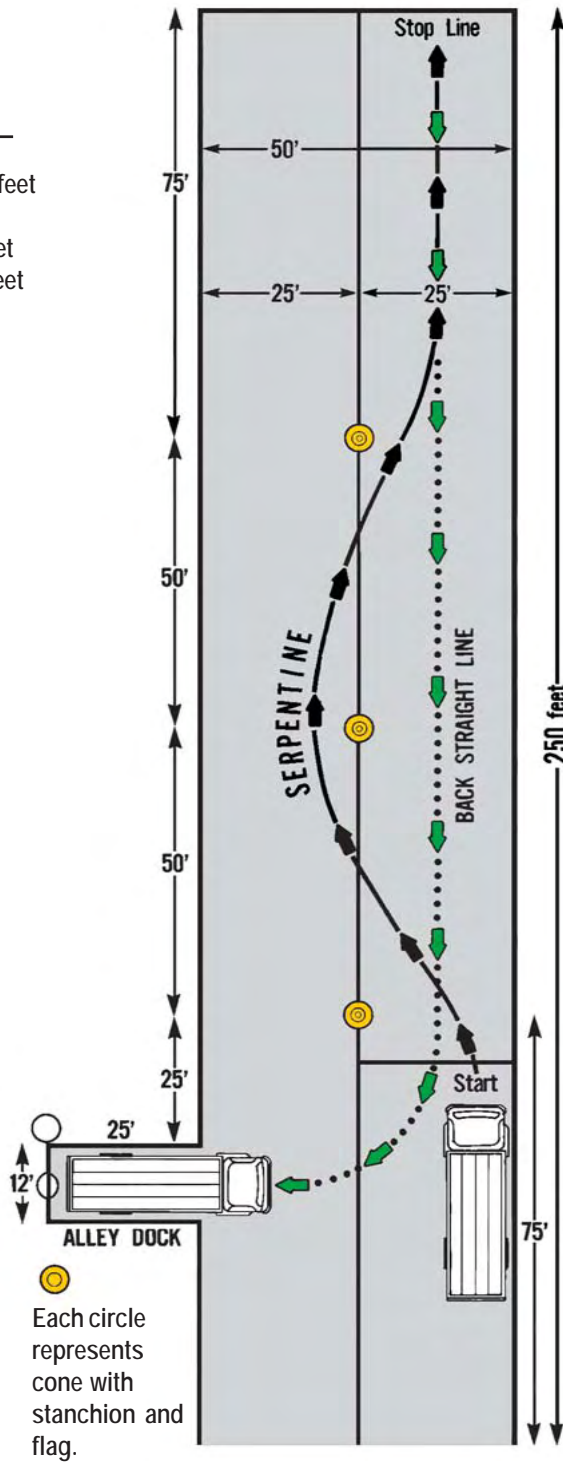



3. Single-unit and double-unit vehicles with a load extending over the maximum length must have a special permit, and a red flag must be attached at the end of the load.
4. A driver must always be aware of the possibility of loads shifting and take the necessary action to prevent this from occurring. Drivers should not operate a vehicle when cargo is not properly balanced and secured.
5. Vehicles with heavy loads often create a traffic hazard when entering a street or highway because they must enter so slowly. Be sure you have sufficient time to move into the line of approaching traffic and give the necessary signal.
6. When approaching an overpass you should be sure there is enough clearance between the vehicle and the overpass.
7. On a short entrance to an interstate when your vehicle is heavily loaded you must look for enough space in traffic to allow for a smooth entrance onto the interstate.

When approaching a green traffic light, you should be alert and prepared to make a smooth stop.

### **Stopping And Parking**

1. Stopping or parking on the open highway should be avoided. Stopping on the shoulder area of a high-speed limited-access highway is particularly dangerous and, except in cases of emergency, is prohibited by law. Never stop just over the crest of a hill or on a curve.
2. When it is necessary to park outside a business or residential district, pull your unit as far to the right, off the traveled portion of the roadway, as is safely possible. You should never leave your truck parked without making sure it cannot be moved.

State law requires that you move your vehicle clear of the traveled portion of the roadway to allow free passage of other vehicles.

### **Parking**

Never park your vehicle in a position where it obscures another driver's view as he attempts to enter a street or highway from a driveway, truck stop or other place.



A. Proper Parking

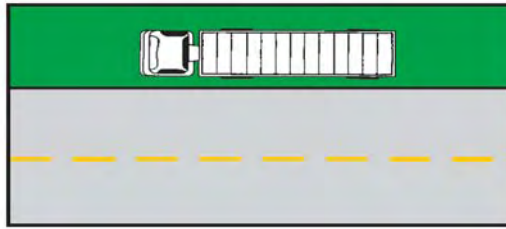

B. Improper Parking

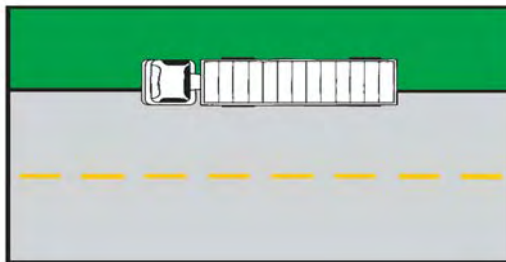

Even when stopping for emergencies, pull your vehicle safely as far off the roadway as possible. On interstates or other limited access highways, use the emergency parking lane (keeping your vehicle entirely off the main roadway).



C. Three Ways of Parking

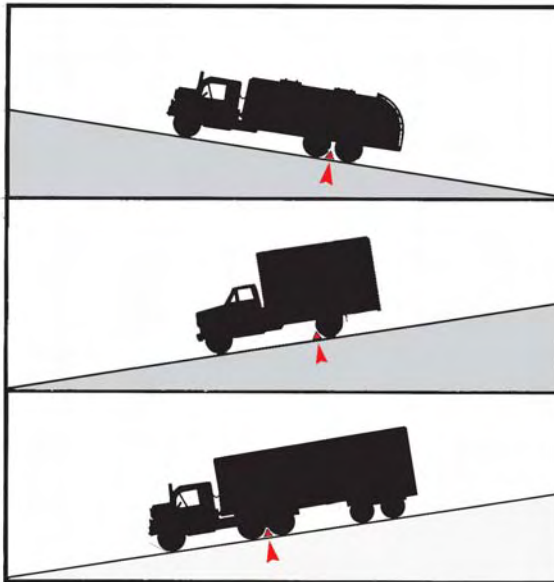

When parking on a hill, use chock blocks to reduce the chances of a runaway vehicle. Recommended placement of blocks indicated in red.



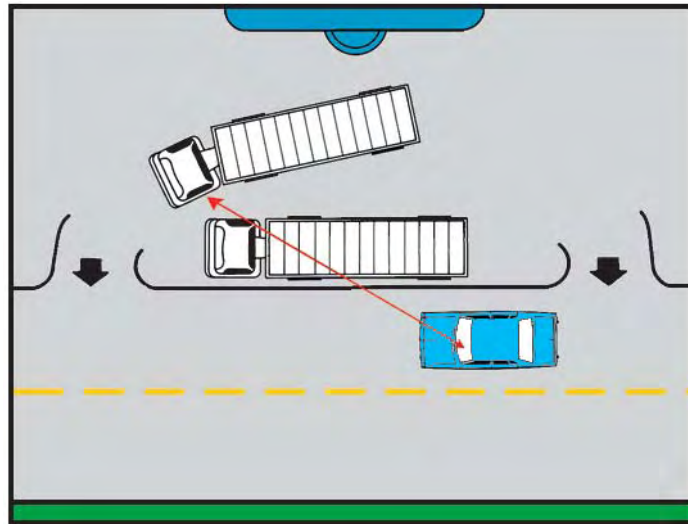

#### Unsafe Parking

Never park your vehicle in such a way that it blocks another driver's view as he attempts to enter a street or highway from a driveway, truck stop or other place.

#### Emergency Stops And Warning Signals

When your vehicle is disabled and you cannot move it off the traveled portion of the roadway, you must put out emergency signals as shown on the next page.

Emergency warning signals may be red flags, pot torches, reflector flares, reflective triangles, red electric lanterns or fuses.

When necessary to stop in the daytime, put out red flags or reflective triangles as follows:

1. Place a warning device at least 100 feet but not more than 500 feet in the center of the lane, both in front of and behind the stopped vehicle.
2. On a divided highway or one-way roadway, place one warning device at least 200 feet to the rear of the stopped vehicle and one at a distance of 100 feet to the rear, in the center of the lane.

When visibility is restricted to less than 500 feet due to fog or similar conditions, use the signals specified for night use.

When necessary to stop at night, immediately turn on your four-way flasher to make the turn signals on both sides of your vehicle flash simultaneously at the front and rear and then place reflective triangles, reflective flares, red electric lanterns or fuses as follows:

1. On a straightway, place one warning device on the traffic side, 10 feet to the rear of the vehicle.

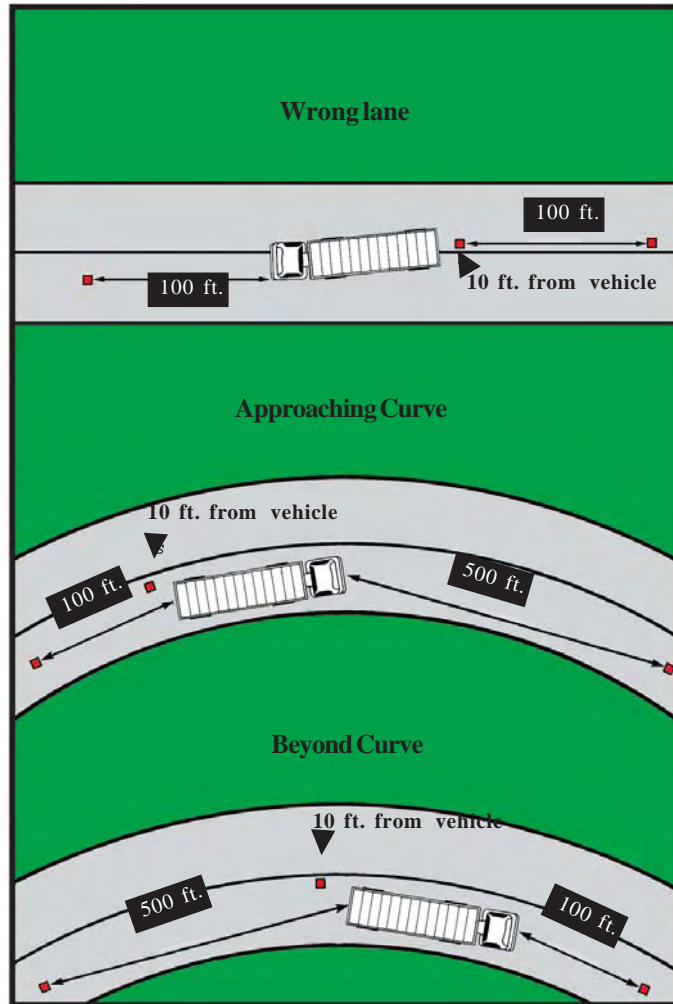

126

Correct placement of warning devices when you are forced to stop your vehicle in an emergency may mean saving your life or the life of another motorist.

2. Next, a warning device at least 100 feet behind the stopped vehicle, in the center of the lane.
3. Another warning device 100 feet ahead of the stopped vehicle, in the center of the lane.
4. One additional warning device, if available, on the traffic side, 10 feet from the front of the vehicle.
5. On a divided highway or one-way roadway, one signal 200 feet and one 100 feet to the rear, in the center of the lane, and one at the traffic side of the vehicle 10 feet to the rear.

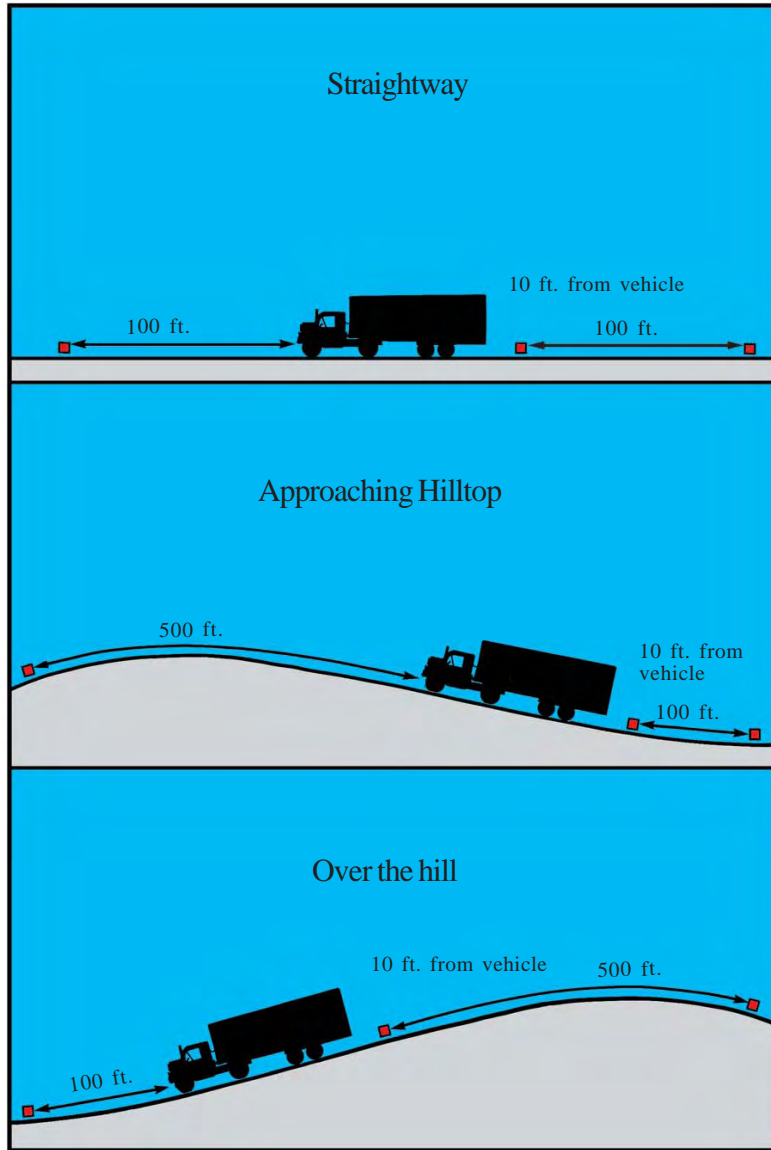

Whenever the view of your stopped vehicle and warning signals is blocked by the crest of a hill, a curve or other obstruction, the warning signal closest to the obstruction to view shall be set at least 100 feet but not more than 500 feet from your vehicle.



### **Fuses Can Be Dangerous**

1. Fuses can cause bad burns. When lighting them, hold the lighted end well away from your body, particularly your face and eyes.
2. Never attach a flame-producing warning signal to any part of your vehicle. It is both dangerous and against the law.
3. In the event of spillage or leakage of fuel, use flame-producing warning signals with caution. Be sure they are placed far enough away from your vehicle to avoid a fire.
4. Avoid the use of flame-producing warning devices on the cargo tanks transporting flammable liquids or flammable compressed gases, or vehicles transporting Explosives, Class A or Class B, or on any vehicle using compressed gas as a fuel.

### **Use Of Four-Way Flasher**

The use of a four-way flasher is recommended as follows:

1. At any temporary stop in a business, residential or open country area when the sight distance is restricted to less than 500 feet and the vehicle cannot be moved clear of the roadway.
2. When parked momentarily in a business area to load or unload freight.
3. Where there is a disabled vehicle, until necessary warning devices are put out.
4. When vehicles are carrying passengers or hauling explosives or flammable materials, and making mandatory stops at railroad grade crossings.
5. In any other situation whenever the vehicle has to be stopped or parked temporarily in a traffic lane or adjacent to a traffic lane.



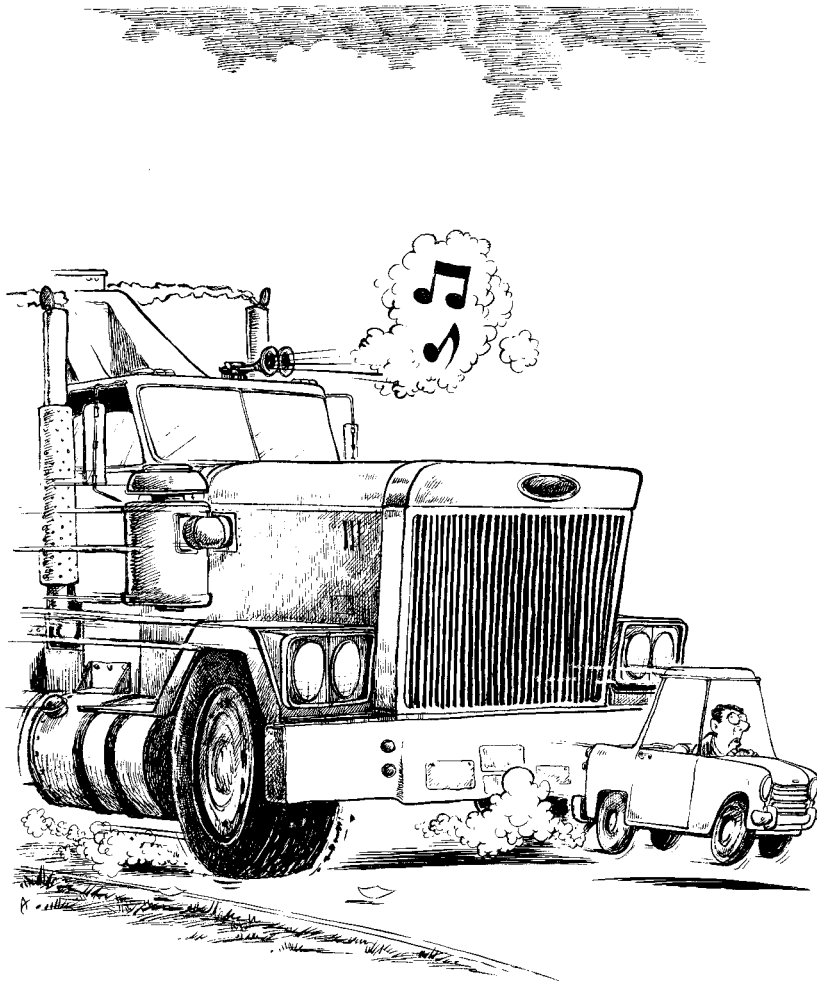

Remember you're bigger than they are. Show respect for other vehicles on the road by leaving appropriate space between you and other vehicles.





130